



SmartStar[®] MiniTower Pro[™]

Instruction Manual

Table of Content

Table of Content	2
1. MiniTower Pro™ Overview	4
1.1. MiniTower Pro™ Features	4
1.2. MiniTower Pro™ Components.....	7
2. MiniTower Pro™ Assembly.....	8
2.1. MiniTower Pro Assembly.....	8
2.2. OTA Mounting and Balancing.....	10
2.3. Operate a MiniTower Pro on Batteries	11
3. GOTONOVA® 8401 Hand Controller.....	12
3.1. Key Description	12
3.2. The LCD Screen	13
3.3. Connection to a Computer	13
4. Getting Started	14
4.1. Level and Align the Mount.....	14
4.1.1. Level the Mount.....	14
4.1.2. Initial Positions	14
4.2. Setting Up the Mount.....	14
4.2.1. Set Up Time Zone.....	15
4.2.2. Set Up Daylight Saving Time.....	16
4.2.3. Set Mount Type.....	16
4.2.4. Set Anti-backlash.....	16
4.2.5. Go to the Moon	17
4.2.6. Initial Star Alignment	17
4.3. Turn Off the Mount.....	17
5. Use the MiniTower Pro.....	18
5.1. Manual Operation of a Telescope.....	18
5.2. Slew to an Object.....	18
5.2.1. Planets, Sun, Moon	18
5.2.2. Deep sky objects	18
5.2.3. Comets	18
5.2.4. Asteroids	18
5.2.5. Stars:	18
5.2.6. Constellations.....	19
5.2.7. User Objects.....	19
5.2.8. Enter R.A. DEC	19
5.3. Sync to Target.....	19
5.4. Set Up Controller	19
5.4.1. Set Up Local Time	19
5.4.2. Set Up Site	19
5.4.3. Set N/S Hemisphere.....	19
5.4.4. Set Display Contrast	19
5.4.5. Set Eyepiece Light	19
5.4.6. Set Backlight.....	19
5.4.7. Set Anti-backlash.....	19

5.4.8. Set Key Beep.....	19
5.4.9. Set Mount Type.....	19
5.4.10. Reset All.....	19
5.4.11. Update Firmware	20
5.4.12. Set Gear Ratio.....	20
5.4.13. Set Language.....	20
5.4.14. A/A Mount Azi Mode.....	20
5.5. Align	20
5.5.1. One Star Align	20
5.5.2. Two Star Align.....	20
5.5.3. Three-Star Align	20
5.5.4. Dis R.A axis error	20
5.5.5. Test Anti-backlash	20
5.5.6. Polaris Position	20
5.6. PEC Option	20
5.7. Set Up Tracking	20
5.8. User Objects.....	21
5.9. Auto Guide.....	21
5.10. Park Scope	21
5.11. To Park Position.....	21
6. Maintenance and Servicing.....	21
6.1. Maintenance.....	21
6.2. Troubleshooting.....	21
6.3. iOptron Customer Service.....	22
Appendix A. Technical Specifications	23
Appendix B. GOTONOVA® 8401 HC MENU STRUCTURE.....	24
Appendix C. GOTONOVA® Star List.....	26
Appendix D. Set Up USB-PC Connection	31
Appendix E. Firmware Upgrade.....	38
Appendix F. Use a PC to Control an iOptron Mount	41
IOPTRON TWO YEAR TELESCOPE, MOUNT, AND CONTROLLER WARRANTY	42



WARNING!

NEVER USE A TELESCOPE TO LOOK AT THE SUN!
Looking at or near the Sun will cause instant and irreversible damage to your eye.
Children should always have adult supervision while observing.

July 2011 V1.2
iOptron reserves the rights to revise this instruction without notice. Actual color/contents/design may differ from those described in this instruction.

1. MiniTower Pro™ Overview

1.1. MiniTower Pro™ Features

MiniTower Pro™ is the perfect combination of capacity and portability.

33 lbs of Payload

Born out of the popular iOptron Cube™, The MiniTower Pro™ is the ultimate observing

solution for people who are searching for a capable and portable GOTO telescope mount to counter light pollution in their backyards and for travel convenience. With a standard payload of 33 lbs, a rock solid 2" stainless steel tripod, metal worm and gear and two dovetail adaptors, The MiniTower Pro™ is capable of handling various optical tube assemblies (OTAs). A 10-lbs counter weight and a secondary dovetail holder are provided for balancing an OTA weights more than 10 lbs, or for a secondary OTA.



Figure 1. MiniTower Pro Mount and Tripod

Extremely Portable

With all the standard components (excluding the tripod) fitted in an aluminum alloy metal case, The MiniTower Pro™ can easily travel in a car or taken as airline

luggage. The system takes about 10 minutes to assemble. This unlimited portability combined with the internal GPS gives amateur astronomers real flexibility in selecting an observing site.



Figure 2. MiniTower Pro in an aluminum case

Accurate GOTO and Tracking

Equipped with our SmartStar[®] GOTO technology, the MiniTower Pro[™] is one of the most powerful and accurate GOTO mounts available on the market. The standard 8401 hand controller offers a superb navigation experience with an 8-line LCD backlit display, a 130,000-object database, and a USB port for easy

connection with ASCOM compliant PC planetarium programs. With a typical GOTO accuracy of 1 arc minute and the SmartStar[®] precision auto-tracking, The MiniTower Pro[™] will consistently bring the celestial object of your choice to the center of the eyepiece and keep tracking for hours.

Additional Unique Features

Equipped with additional features such as automatic over-current protection, automatic clutch protection for both axes, easy 3-point

level adjustment, dual scope setup with two dovetails and more-- The MiniTower Pro™ is one of the most user-friendly GOTO mounts available today.



Figure 3. MiniTower Pro with dual scope setup

1.2. MiniTower Pro™ Components¹

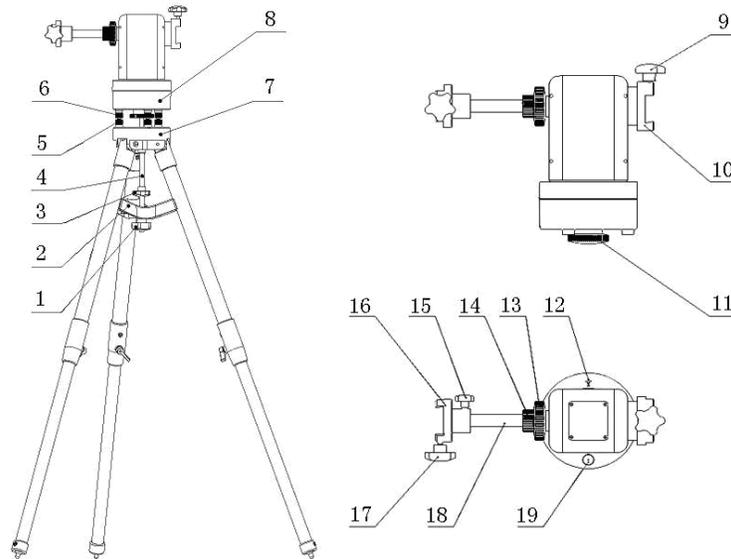

Figure 4. MiniTower Pro Components

Shown in the picture:

- | | |
|-------------------------------------------------------------------|--------------------------------------|
| 1. Tripod Lock | 10. Primary Dovetail Holder |
| 2. Tripod Support | 11. Azimuth Clutch Lock |
| 3. Tripod Knob | 12. South Alignment Mark |
| 4. Tripod Rod | 13. Altitude Clutch Lock |
| 5. Level Adjustment Lock <i>(not included with MiniTower Pro)</i> | 14. Counter Balance Shaft Lock |
| 6. Level Adjustment Screw | 15. Secondary Dovetail Holder Lock |
| 7. Tripod | 16. Secondary Dovetail Holder |
| 8. Mount Base | 17. Secondary Dovetail Lock |
| 9. Primary Dovetail Lock | 18. Retractable Counter Weight Shaft |
| | 19. Bubble Level Indicator |

Not shown in picture:

- 8401 Hand Controller
- Controller Cable
- AC Adapter
- 12V DC Adapter with Car Lighter Plug
- USB Cable
- Counter Weight
- Counter Weight Lock Pin
- Counter Weight Lock
- Hard Travel Case

¹ The contents may vary slightly by generation.

2. MiniTower Pro™ Assembly

There are two shipping boxes. One box contains the hard case and mount components. The other box contains the tripod and counterweight.

2.1. MiniTower Pro Assembly



Figure 5

1. Setup tripod. Extend tripod legs to full extension. Then lock legs using the lock knobs on sides.

Next expand the legs out to their maximum position.



Figure 6

2. Assemble the three prong washer and azimuth clutch lock (#11) onto the mount base



Figure 7

3. Carefully position telescope mount onto the tripod by aligning the three holes on the bottom of the mount base (#8) to the three level adjustment screws (#6) on the top of the tripod (#7), hold the mount with your hands.

Adjust level adjustment screws (#6) to level the mount using the bubble level on the base.

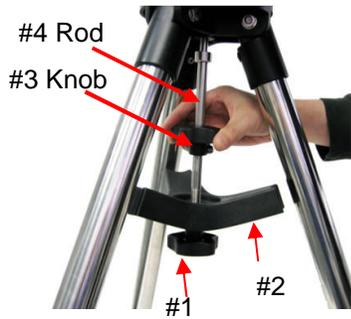

Figure 8

4. Secure the mount to the tripod by using the long tripod rod (#4). Hand tighten the rod into the bottom of the mount by turning the tripod knob (#3).

Next, slide tripod support (#2) onto bottom of rod (#4). Position the three edges to fit against the three tripod legs. Then hand tighten tripod lock knob (#1) to secure the tripod support in place.

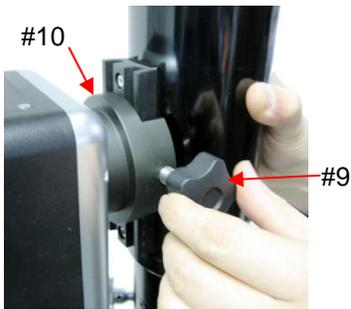

Figure 9

5. Attach an OTA to the primary dovetail holder (#10) using the primary dovetail lock (#9).

Tighten both the azimuth clutch lock (#11) and the altitude clutch lock (#13)



Figure 10

6. Plug one end of supplied 6pin RJ-11 cable into either one of the two HBX (Handbox) sockets on the mount; plug the other end into the GOTO NOVA 8401 hand controller. Plug in 12V power cable.

Turn on power. Now you are ready to observe. Use the 4 Arrow keys (▲▼◀▶) to rotate the scope Up, Down, Left, and Right. Use the number key to change the slew speed from the slowest (1:1X) to the fastest (9:MAX).

The other HBX is reserved for accessories, such as electronic focuser, laser pointer and autoguider adapter. **DO NOT plug non-iOptron accessories into the unit to avoid damaging the mount or accessories.**



Figure 11

7. This step allows you to attach the counterweight or a second scope. (note: if you have a light scope less than 10 lbs. on the primary side, then attaching a counterweight is optional).

First, make sure the altitude clutch lock (#13) is tight. Loose the counter weight shaft lock (#14), pull the counter weight shaft (#18) out and tighten the counter balance shaft lock (#14).

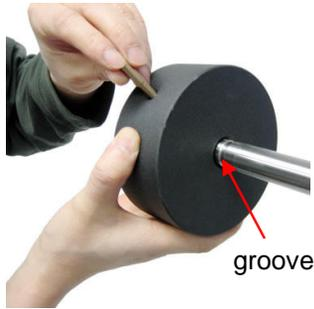

Figure 12



Figure 13

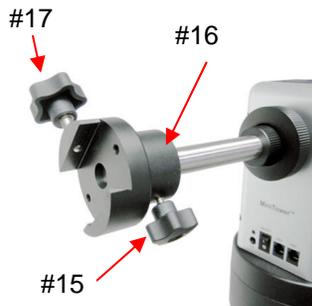

Figure 14

If you are attaching a second scope, do not add the counterweight. **Instead, skip to Step 10 to add a second scope.**

8. Slide the counterweight onto the counterbalance shaft (#18). Next, insert the brass pin into the hole on the counterweight.

9. Secure the counterweight by tightening the lock knob.

⚠ Counter weight is heavy. Please handle with care to avoid injury!

This step is for attaching a second scope.

10. Attach Secondary Dovetail Holder (#16) by tightening the holder lock (#15) onto the counterweight shaft (#18).

After sliding your scope into the dovetail holder—secure the scope by tightening the secondary lock (#17)

2.2. OTA Mounting and Balancing

The iOptron MiniTower Pro™ can handle various OTAs. A dovetail plate is needed to mount an OTA onto the MiniTower Pro mount. The width of the MiniTower Pro™ dovetail holder is 1.75”.

Most telescopes come with a dovetail plate installed on the bottom of the telescope. If the size of dovetail plate does not match un-screw the plate and install an appropriate dovetail plate that matches the holder. 1.75” dovetail plates are available from iOptron at www.iOptron.com (part number #8422) or visit an online or local camera store.

Some telescopes may not have screw holes on the bottom. In this case you may need compatible mounting rings to attach the dovetail plate. The size of the mounting rings should match the aperture of your OTA.

The counter weight (CW) is always helpful to balance the OTA in order to have smooth and accurate GOTO and tracking. The heavier the OTA, the more necessary it is to use a CW. For lightweight OTAs, i.e. 5-6 lbs, however, the CW may not be necessary.

If you have a secondary OTA on the secondary dovetail holder, make sure you align it with the primary OTA. This alignment is done easier during the daytime. Point the primary telescope to a target at a remote building or flagpole and center the target in the eyepiece. Loosen the secondary dovetail holder lock (#15). Rotate the secondary OTA around the counter balance shaft (#18). Center the object in the eyepiece of the secondary OTA. If the secondary OTA is tilted, it can be adjusted by two tilting adjustment screws as shown in Figure 15 (M6 x 12mm Allen set screws, not supplied).

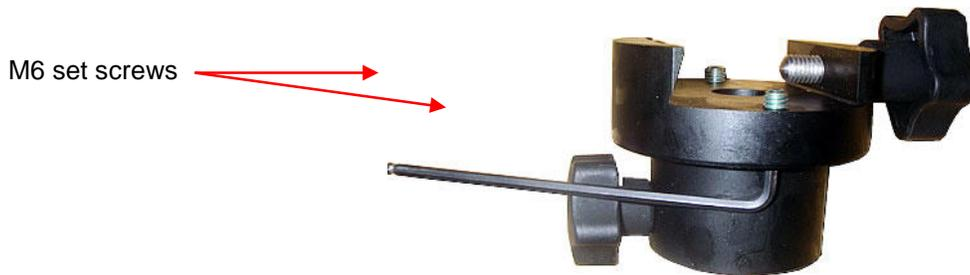

Figure 15. Secondary Dovetail and set screws

A combination of a light OTA and a CW can be used to balance a heavier primary OTA.

2.3. Operate a MiniTower Pro on Batteries

To install batteries open the battery compartment door. Pull the battery holder out from the mount carefully making sure not to pull the wires loose. Insert 8 AA batteries (not included) according to the diagram on the holder. Replace the battery holder back to the battery compartment and replace the cover. (See Figure 16)



Figure 16. Battery compartment for MiniTower Pro™

The mount will draw a significant amount of current when performing GOTO and slew operations. The battery operation time varies depending on the battery quality and operation conditions. It could last from couple of hours to tens of hours. Use only fresh batteries and do not mix fresh and old batteries. Insufficient battery power may cause error messages.

3. GOTONOVA® 8401 Hand Controller



Figure 17. GOTONOVA 8401 Hand Controller

GOTONOVA® 8401 hand controller (HC) is the standard controller for a MiniTower Pro, as shown in Figure 17.

3.1. Key Description

- MENU: Press “MENU” to enter the Main Menu.
- BACK: Move back to the previous screen, or end/cancel current operation, such as slewing.
- ENTER: Confirm an input, go to the next menu, select a choice, or slew the telescope to a selected object.
- Arrow (▲▼▶◀): Press ▲▼ buttons to move a telescope along the DEC direction, ▶◀ to move a telescope along the RA direction. Brows the menu or move the cursor in operating menu.
- Number Keys: Input numerical values. Also used to adjust speeds (1: 1X; 2: 2X; 3: 8X; 4: 16X; 5: 64X; 6: 128X; 7: 256X; 8: 512X; 9: MAX)

- Light Key(☀): Turns on/off the red LED reading light on the back of the controller.
- ? Key: For help or extra information.
- STOP/0 Key: Stop/Start tracking.
- HBX (Handbox) port: connect the HC to MiniTower Pro mount using a 6-wire RJ11 cable.
- USB port: connect the HC to a Computer via a USB cable.

3.2. The LCD Screen

The 8401 HC is designed to use for both iOptron's equatorial (EQ) mount, such as the SmartStar®-PR GOTO German Equatorial Mount and the GOTONOVA® Equatorial Kit, and AltAzimuth (A/A) mount, which includes all SmartStar® GOTO mounts and telescopes. It consists of a large 8-line LCD screen, which displays all the information as shown in Figure 18. The user interface is simple and easy to learn.

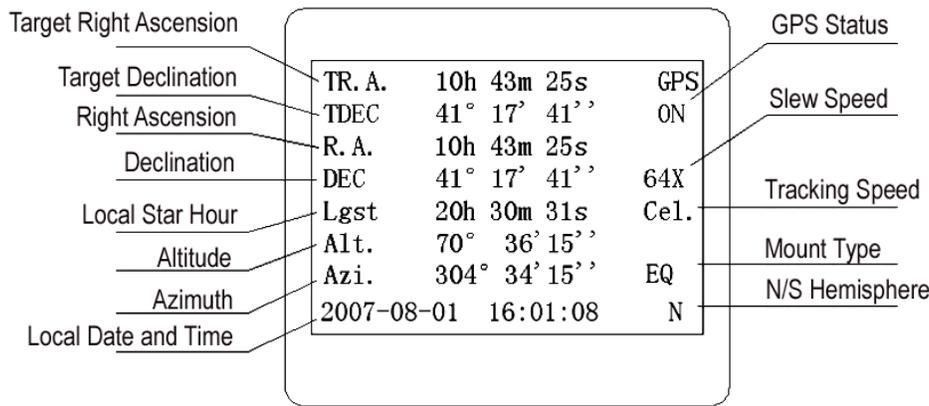

Figure 18. 8401 HC LCD Information Screen

- GPS status: When the power is turned on, it shows "GPS ON", which means a GPS receiver is connected. When the GPS receiver finds the satellite and receives GPS signal, it shows "GPS OK". The "GPS OK" may turn off after few minutes.
- Slew speed: It has 9 speeds: 1X, 2X, 8X, 16X, 64X, 128X, 256X(1°/sec), 512X(2°/sec), MAX(~ 4°/sec).
- Tracking speed: It has 4 speeds: Cel (celestial), Sol (Solar), Lun (Lunar), Def (user defined)
- Mount Type: EQ is equatorial and A/A altazimuth.

3.3. Connection to a Computer

The GOTONOVA hand controller has a USB port which can be connected to a computer. This will allow Firmware Upgrading, Database Updating, or Planetarium application. A USB2COM driver is needed to simulate the USB port to a RS-232 serial port. (see Appendix D)

The MiniTower Pro™ can be controlled by a number of popular astronomy software programs. For astronomy software that does not have an embedded iOptron mount driver, an ASCOM driver and related platform are needed. Please refer to Appendix F for more information.

4. Getting Started

In order to experience the full GOTO capability of GOTO NOVA technology it is very important to set up the mount correctly before observation.

First, loosen tripod rod (#4) and tripod lock (#1) a little. Then loosen azimuth clutch lock (#11) half turn. Check the bubble level indicator (#19), adjust the level adjustment screws (#6), and center the bubble in the indicator. Turn the mount by a hand and make sure that the mount is leveled on all sides while turning. Adjust the level adjustment screws again if the bubble is not centered while turning.

Tighten the azimuth clutch lock (#11). Tighten the tripod knob (#3). Tighten the

4.1.2. Initial Positions

Each time the Mount is turned on, the default position is Parking Position, *i.e.*, altitude is $90^{\circ}0'0''$ and azimuth is $180^{\circ}0'0''$,

Face the South. Align the Mount to south by turning the South mark facing south. An additional compass is needed. There are two ways to do so. One is loosen the azimuth clutch lock (#11) a little and manually turn the Mount to face south. Then tighten the azimuth clutch lock again. The other is turn on the mount. Turn the mount facing south using hand control. Then turn off the power. **Note:** Do not put the compass directly on top of the mount. The motor parts of the mount could affect the pointing accuracy of the compass.

Point to Zenith. Unlock the altitude clutch lock (#13) and rotate the telescope to point up directed at the Zenith. A torpedo level may help.

Once it is straight re-tighten the altitude lock to make sure OTA is secure and will not spin.

4.1. Level and Align the Mount

4.1.1. Level the Mount.

Leveling is critical for a good GOTO and tracking accuracy.

tripod lock (#1). Make sure the mount is always leveled.



Figure 19

which means the “SOUTH” mark is pointing to south and the telescope is pointing straight up at the zenith. To set the Park Position, you can:

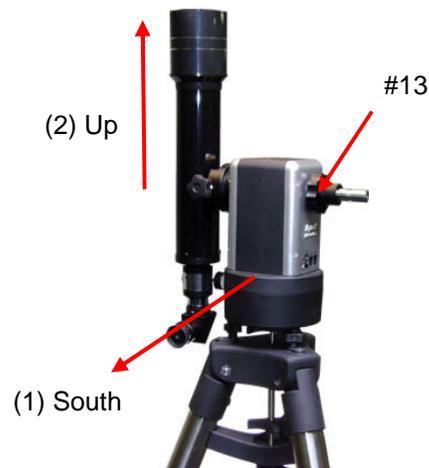

Figure 20

4.2. Setting Up the Mount

A MiniTower Pro is equipped with a GPS receiver, which will receive the local time,

longitude and latitude information from satellites after the link is established. However, manual input is still needed for time zone and Daylight Saving setting.

A clear sky outside is needed for GPS to communicate well with the satellites.

4.2.1. Set Up Time Zone

Press MENU button, from the main menu, scroll down and select “Set up controller”

```
Select and slew
Sync. to target
Electronic focuser
Set up controller
Align
PEC option
Set up Tracking
User objects
```

Press ENTER. Scroll down and select “Set up site”

```
Set up Local Time
Set up site
Set N/S hemisphere
Set display contrast
Set Eyepiece light
Set Backlight
Set anti-backlash
Set Key Beep
```

Press ENTER. The longitude and latitude coordinates will be updated when the GPS picks up satellite signals. “W/E” means west/east hemisphere; “N/S” means northern/southern hemisphere; “d” means degree; “m” means minute; and “s” means second.

```
Set up site info:
Longitude:
    W071d27m47s
Latitude:
    N42d15m40s
300 Min. behind UT
```

If for any reason your GPS can’t pick up a signal you can manually enter the GPS

coordinates. Press ◀ or ▶ key to move the cursor and using ▲ or ▼ key to toggle between “W” and “E”, “N” and “S”, using number key to change the numbers. It is always a good idea to do your home work to get the GPS coordinates before traveling to a new observation site.

The site coordinates information can be found from internet, such as GPSVisualizer (<http://www.gpsvisualizer.com/geocode>), by entering the city name or address. In case you only find the site information in decimal format you can convert them into d:m:s format by multiplying the decimal numbers by 60. For example, N47.53 can be changed to N47°31'48": $47.53^\circ = 47^\circ + 0.53^\circ$, $0.53^\circ = 0.53 \times 60' = 31.8'$, $0.8' = 0.8 \times 60" = 48"$. Therefore, $47.53^\circ = 47^\circ 31' 48"$ or 47d31m48s. Same as N47°31.8': $31.8' = 31' + 0.8'$, $0.8' = 0.8 \times 60" = 48"$.

Press ◀ or ▶ key, move the cursor to the bottom of the screen to set the time zone information (add or subtract 60 minutes per time zone). Enter minutes “ahead of” or “behind” UT (universal time).

- New York City is 300 minutes “behind” UT
- Los Angeles is 480 minutes “behind” UT
- Rome is 60 minutes “ahead of” UT
- Beijing is 480 minutes “ahead of” UT
- Sydney is 600 minutes “ahead of” UT

All the time zones in North America are *behind* UT, as shown in the following table. So make sure it shows “behind” instead of “ahead of” UT.

Time Zone	Hours behind	Enter Minutes
Hawaii	-10	600
Alaska	-9	540
Pacific	-8	480
Mountain	-7	420
Central	-6	360
Eastern	-5	300

To adjust minutes, move the cursor to each digit and use the number keys to input number directly. To change the “behind” or “ahead of” UT, move the cursor to “ahead” and using ▲ or ▼ key to toggle between “behind” and “ahead”. When the number is correct, press ENTER and go back to the previous screen.

For other parts of the world you can find your “time zone” information online at websites such as <http://www.timeanddate.com/worldclock/>. DO NOT COUNT DAYLIGHT SAVING TIME.

4.2.2. Set Up Daylight Saving Time

Scroll up and select “Set up local Time”

```
Set up Local Time
Set up site
Set N/S hemisphere
Set display contrast
Set Eyepiece light
Set Backlight
Set anti-backlash
Set Key Beep
```

Press ENTER.

```
Set local time:

2008-06-01 11:55:09
Daylight Saving Time Y
```

Use the ◀ or ▶ key to move the cursor to the bottom of the screen, use the ▲ or ▼ button to toggle between “Y” and “N”. Press ENTER to go back the previous screen. The local time also can be manually entered in case of GPS malfunction or testing the mount inside.

The time and site information will be stored inside HC memory chip. If you are not traveling to other observation site, they do not need to be changed.

4.2.3. Set Mount Type

The #8401 hand controller that comes with the MiniTower Pro can function in both EQ and AltAz. For the MiniTower Pro you will need to set the hand controller to function in AltAz. Scroll down and select “Set Mount Type”,

```
Set up site
Set N/S hemisphere
Set display contrast
Set Eyepiece light
Set Backlight
Set anti-backlash
Set Key Beep
Set Mount Type
```

Press Enter.

```
Equatorial Mount
Alt/Azi Mount
```

Select Alt/Azi mount and press ENTER to go back the previous screen.

4.2.4. Set Anti-backlash

For an Alt/Azi operation, both R.A. and DEC anti-backlash should be set to 0 step. Scroll down and select “Set anti-backlash”

```
Set up Local Time
Set up site
Set N/S hemisphere
Set display contrast
Set Eyepiece light
Set Backlight
Set anti-backlash
Set Key Beep
```

Press ENTER. A R.A. anti-backlash will display:

```
R.A. anti-backlash:
    0150    steps

One step equals to
  1.5 arc second.
```

To adjust steps move the cursor to each digit and use the number keys to input number directly. Press ENTER – “DEC anti-backlash” will display:

```
DEC anti-backlash:
    0150    steps

One step equals to
  1.5 arc second.
```

Move the cursor to each digit and use the number keys to set the anti-backlash to 0. Press ENTER to go back the previous screen.

Press BACK button to go back to main menu.

4.2.5. Go to the Moon

After performing these set-ups the mount is ready to GOTO and track objects. One of the most common objects is the Moon.

To slew to the Moon press MENU button. Select “Select and slew” by pressing the ENTER button. Select “Planets, Sun, Moon”, and use the ▲ or ▼ buttons to select Moon. Press ENTER. The telescope will automatically slew to the Moon and lock on. It will automatically begin to track once it locks on. Use the arrow keys to center the Moon in your eyepiece if it is not centered. Or for better performance use Sync to Target (see instructions later).

4.2.6. Initial Star Alignment

A simple star alignment/synchronization can be performed to improve the GOTO and tracking accuracy. To do so, after slew the mount to an object, such as Moon, press MENU button, scroll down to “Sync. To Target”, follow the on-screen instruction and press ENTER.

An alternate way is to perform an “Easy One Star Align”. To do so, press MENU button, scroll down to “Align”, select “Easy One Star Align” and press ENTER. The screen will list three bright objects for you to select from (ex. Moon, Jupiter, Venus). Select an object using ▲ or ▼ key. Then press ENTER. Next use the arrow keys to slew to the object until it is centered in your eyepiece. Then press ENTER.

You may need to use the number keys to change the slewing speed to make the centering procedure easier.

4.3. Turn Off the Mount

When you are finished observing it is recommended to return the mount to Park Position. If the mount is not moved then no initial set up is needed when you turn on the mount next time. To park the telescope press the MENU button, scroll down to “Park Telescope” and press ENTER. Once the telescope returns to Park Position turn the power off.

5. Use the MiniTower Pro

5.1. Manual Operation of a Telescope

You may observe land and astronomical objects using GOTONOVA's arrow keys.

After the telescope was assembled (referring to Section 2. Telescope Assembly), flip the I/O switch on the telescope mount to turn on the mount. Use ►, ◀, ▼ or ▲ buttons to point the telescope to the desired object. You may need to use the number keys to change the slewing speed. Simply press a number while slewing to change the slew speed.

5.2. Slew to an Object

Press the MENU button. From the main menu, select "Select and Slew." Select an object that you would like to observe and press the ENTER key.

The GOTONOVA™ 8401 hand controller has a database of about 130,000 objects. Use the ► or ◀ buttons to move the cursor and the ▼▲ buttons to change the individual number. The check mark (√) indicates the object is above the horizon, and a cross mark (X) means it is below the horizon. In some catalogs those stars below the horizon will not display on the hand controller.

5.2.1. Planets, Sun, Moon

There are 10 objects in the Solar system catalog.

5.2.2. Deep sky objects

This menu includes objects outside our Solar system such as galaxies, star clusters, quasars, and nebulae.

- Named Deepsky Objects: consists of 60 deep sky objects with their common

names. A list of named deep sky objects is attached in Appendix C.

- Messier Catalog: consists of all 110 objects.
- NGC IC Catalog: consists of 7840 objects in NGC catalog and 5386 objects in IC catalog. To select an object from NGC or IC catalog, move the cursor to NGC, using ▲ or ▼ button to toggle between NGC and IC. Then move the cursor to numerical position and use the number button to select the object.
- UGC Catalog: consists of 12939 objects.
- MCG Catalog: consists of 29004 objects. They are listed numerically from MCG+15 to MCG-05.
- Caldwell Catalog: consists of 109 objects.
- Abell Catalog: consists of 2712 objects.
- Herschel Catalog: consists of 400 objects.

5.2.3. Comets

This catalog contains up to 190 comets. This database is customer upgradeable.

5.2.4. Asteroids

This catalog contains up to 4096 asteroids. This database is customer upgradeable.

5.2.5. Stars:

- Named Stars: consists of 191 stars with their common names. They are listed alphabetically. A list is attached in Appendix C.
- Double Stars: consists of 40 double stars. A list is attached in Appendix C.
- GCVS Variable Stars: consists of 38624 GCVS variable stars. They are listed numerically.

- SAO Catalog: consists of 26584 SAO catalog objects. They are listed numerically.

5.2.6. Constellations

This catalog consists of 88 modern constellations with their names. They are listed alphabetically. A list is attached in Appendix C.

5.2.7. User Objects

This catalog can consist up to 256 user predefined objects. These objects need to be entered before they can be selected for slewing.

5.2.8. Enter R.A. DEC

Here you can go to a target by entering its R.A. and DEC numbers.

5.3. Sync to Target

This operation will match the telescope's current coordinates to Target Right Ascension and Declination. After slew to an object, press MENU—then scroll to “Sync to Target” and press ENTER. Follow the screen to do the sync. Using this function will re-calibrate the computer to the selected object. Multiple syncs can be performed if needed.

“Sync to Target” will only work after “Select and slew” is performed. Otherwise, the system may perform incorrectly. You can change the slewing speed to make the centering procedure easier. Simply press a number (1 through 9) to change the speed. The default slew speed is 64X.

“Sync to Target” does the same thing as one star alignment except that you choose the object to “sync” to. One star alignment chooses the star/object for you.

5.4. Set Up Controller

5.4.1. Set Up Local Time

Refer to 4.2.2.

5.4.2. Set Up Site

Refer to 4.2.1.

5.4.3. Set N/S Hemisphere

Set northern or southern hemisphere.

5.4.4. Set Display Contrast

Use arrow keys to adjust LCD display contrast.

5.4.5. Set Eyepiece Light

If you have an illuminated-reticule eyepiece or illuminated polar scope, and it is supported by GOTONOVA hand controller-- use this option to adjust the light intensity.

5.4.6. Set Backlight

Adjust LCD and keypad backlight.

5.4.7. Set Anti-backlash

Use Array Keys to move the cursor and Number Keys to change the number. 0 is suggested for Alt/Azi mount.

5.4.8. Set Key Beep

Turn the key beep on/off.

5.4.9. Set Mount Type

Select Alt/Azi for MiniTower Pro.

5.4.10. Reset All

Reset all settings to factory default data.

5.4.11. Update Firmware

Firmware updating using iOptron Downloader through USB port on hand controller. (Refer to Appendix E.)

5.4.12. Set Gear Ratio

Not applicable.

5.4.13. Set Language

Select hand controller language, English or French.

5.4.14. A/A Mount Azi Mode

This function will command the mount to go to an celestial object with a shortest path or maybe a longer path to avoid power cord wrapping. Select **AZI 0 ~ 360 degree** for anti-cordwrapping, or **AZI free running** for shortest goto path.

5.5. Align

This function is used for aligning the telescope.

5.5.1. One Star Align

From the main menu select "Align". Select "One Star Align". Use ▲ and ▼ buttons to select a star and press ENTER. A list of align planets or stars that are above the horizon is computed based on your local time and location. Use arrow buttons to move the telescope and center the star in your eyepiece. You can use the number buttons to change the slew speed.

Press ENTER when finished. If your setup is leveled well, one star alignment should be sufficient for good GOTO accuracy. To increase the accuracy you may choose to do two star alignment.

5.5.2. Two Star Align

Two star alignment will increase the GOTO accuracy of the mount. It is suggested to do two star alignment after one star alignment. Two star alignment requires a wider view of the sky, since the two align stars need to be far apart. Select "Two Star Align" in the Align menu. When you finish the first star, the system will prompt you to choose the second star. If the star you choose is too close to the first one, the system will let you choose another one. When you are aligned with the second star, two star alignment is finished. You can reject the suggested star if it is blocked by the tree or behind the house.

"Two Star Align" results will be overridden if "One Star Align" or "Sync. to Target" is performed after "Two Star Align."

5.5.3. Three-Star Align

Not supported for Alt/Azi.

5.5.4. Dis R.A axis error

Not supported for Alt/Azi mode.

5.5.5. Test Anti-backlash

Not supported for Alt/Azi mode.

5.5.6. Polaris Position

This shows Polaris position.

5.6. PEC Option

Periodic Error Correction (PEC) is not supported for MT Pro.

5.7. Set Up Tracking

A user can set up tracking in the main menu by selecting "Set up tracking". Then the user

can select “Sidereal speed”, “Solar speed”, “Lunar speed”, and “User defined speed”. For “User defined speed” this can be adjusted from 91% to 109% of sidereal speed by pressing the ▲ or ▼ buttons.

5.8. User Objects

Besides various star lists available in the hand controller --you can add, edit or delete your own user-defined objects. All data you enter is supposedly J2000.0 epoch.

5.9. Auto Guide

This function is not supported in Alt/Azi mode.

5.10. Park Scope

This procedure only needs to be done if you do not move your telescope mount after you power off the GOTO NOVA. Celestial pole pointing error will be stored to flash memory and recalled when you power on again.

5.11. To Park Position

This moves your telescope to park position. When power is turned on--the mount assumes the physical position is the park position. This is its reference point for all other objects.

6. Maintenance and Servicing

6.1. Maintenance

The MiniTower Pro is designed to be maintenance free. Do not overload the mount. Do not drop the mount which will damage the mount or affect the GOTO tracking accuracy permanently. Use a wet cloth to clean the mount and hand controller. Do not use solvent.

If your mount is not to be used for an extended period, dismount the OTAs and counterweight. Remove the batteries from the battery holder if they were installed.

6.2. Troubleshooting

The following suggestions may be helpful for the operation of the MiniTower Pro. More information can be found in our online FAQ section (www.iOptron.com then click on “support”).

1. Error Message “Warning! DEC. (or R.A.) driver motor over current. Please check balance.”

- (1) Check if the mount or OTA is blocked by any obstructions.
- (2) Try to operate the mount without an OTA.
- (3) Check the power supply. This is a common reason for this message and **unexpected slew behavior or movement**, which include:
 - Batteries: Are the batteries fresh? How long have they been used? (frequent slewing and GOTO will deplete battery power very quickly)
 - AC or DC adapter: Check the plugs to the mount and to the power outlet.
 - Extension cord: Make sure the cord is in good condition. Power drop along the extension cord has been known to cause this error message. Also check all the plugs and connections.
- (4) Check the hand controller cord. Unplug it and re-plug into the other HBX port.

2. Error Message “Warning! Can not communicate with DEC motor controller.”

- (1) Check the hand controller cord. Unplug it and re-plug into another HBX port.
- (2) Check the power supply, which include:
 - Using the battery? Is the battery fresh? How long it has been used? (frequent

slew and GOTO will deplete battery power very quickly)

- Using AC or DC adapter? Check the plugs to the mount and to the power outlet.
- Using extension cord? Make sure the cord is in good condition. Power drop along the extension cord was known to cause the problem. Also check all the plugs and connections.

3. The object is jumping up and down in the eyepiece or over-slewed, and other unexpected slew behavior or movement.

- (1) Use most updated firmware.
- (2) Set backlash to 0 in both DEC and RA.
- (3) Check the power supply, which include:
 - Using the battery? Is the battery fresh? How long it has been used? (frequent slew and GOTO will deplete battery power very quickly)
 - Using AC or DC adapter? Check the plugs to the mount and to the power outlet.
 - Using extension cord? Make sure the cord is in good condition. Power drop along the extension cord was known to cause the problem. Also check all the plugs and connections.
- (4) System balancing.

4. Star Alignment accuracy; GOTO accuracy

- (1) Leveling (very important).
- (2) Site information (minutes ahead or behind UT, DST).
- (3) System balancing.
- (4) Use most updated firmware.
- (5) Select right mount type (A/A).
- (6) Set backlash to 0 in both DEC and RA.
- (7) Check the power supply, which include:
 - Using the battery? Is the battery fresh? How long it has been used? (frequent slew and GOTO will deplete battery power very quickly)

- Using AC or DC adapter? Check the plugs to the mount and to the power outlet.
- Using extension cord? Make sure the cord is in good condition. Power drop along the extension cord was known to cause the problem. Also check all the plugs and connections.

6.3. iOptron Customer Service

If you have a question concerning your MiniTower Pro contact the iOptron Customer Service Department. Customer Service hours are 9:00 AM to 5:00 PM, Eastern Time, Monday through Friday. In the unlikely event that the MiniTower Pro requires factory servicing or repairs, write or call the iOptron Customer Service Department first to receive an RMA# before returning the telescope to the factory. Please provide details as to the nature of the problem as well as your name, address, and daytime telephone number. We have found that most problems can be resolved via e-mails or by telephone calls. So please contact us at:

e-mail: support@ioptron.com

Telephone: 1.781.569.0200

1.866.399.4587

Appendix A. Technical Specifications

Mount	AltAzimuth Mount
Body Materials	Die-cast Aluminum
Motor	Dual-Axis DC Servomotor, DC12V
Gear	Aluminum worm wheel/brass worm gear
Bearing	4 high precision bearings
Speed	Dual-Axis, 9-Gear, Electronic (1x,2x,8x,16x,64x,128x,256x,512x,MAX)
GPS	32-channel GPS
GOTO System	GOTONOVA [®] 130,000 objects database
Resolution	0.1 Arc Sec.
Tracking	Automatic
Payload	33 lb
Second Payload	10 lb
Tripod	2" Stainless Steel
Battery	AA x 8 (Not Included)
Power Requirement	DC 12V±2V, >1.2A
USB Port	Yes (on hand controller)
Protocol	ASCOM
Firmware Upgrade	Yes
PC Computer Control	Yes (via USB port)
Weight with tripod	48 lbs. (shipping weight)

Appendix B. GOTONOVA[®] 8401 HC MENU STRUCTURE

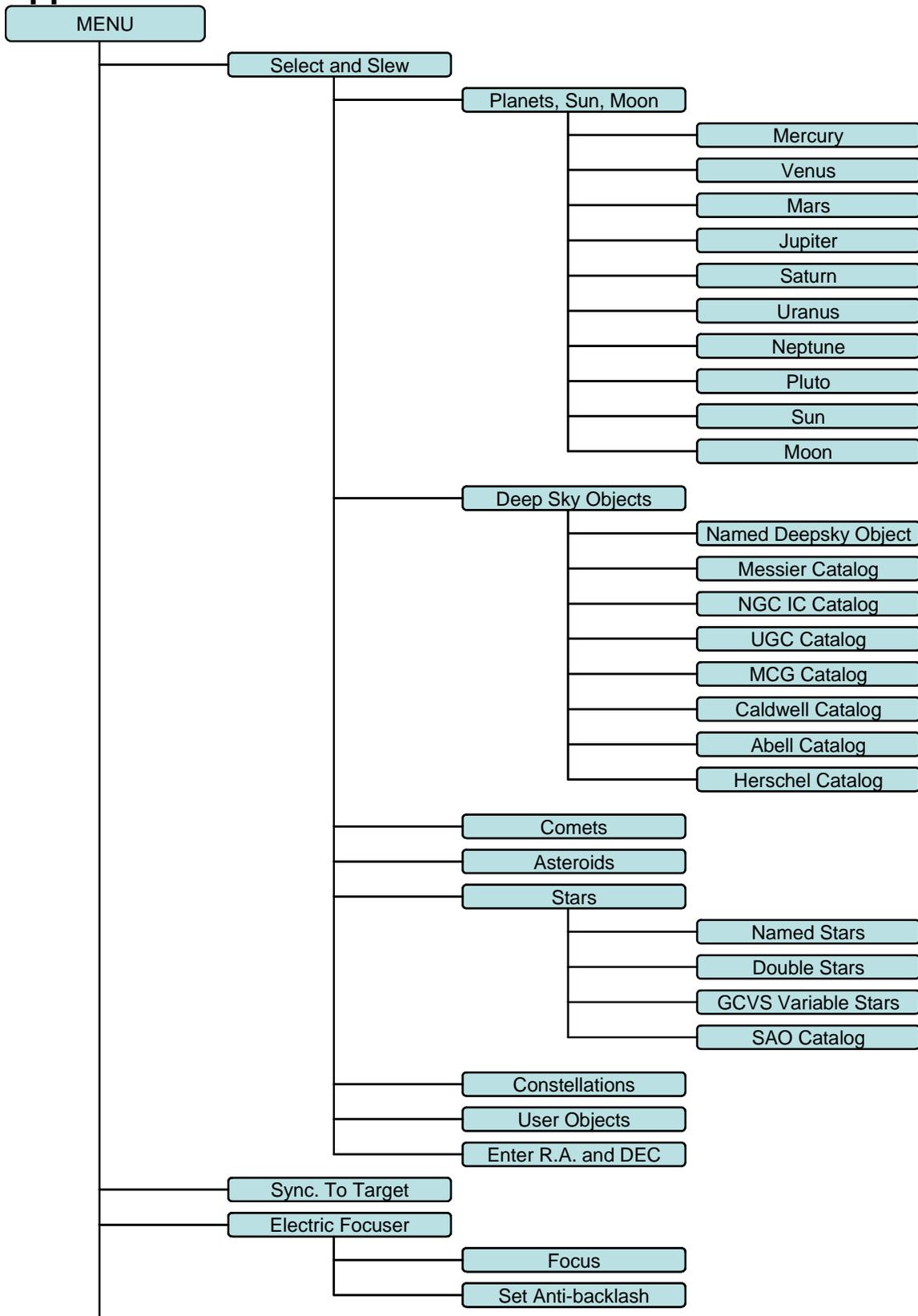

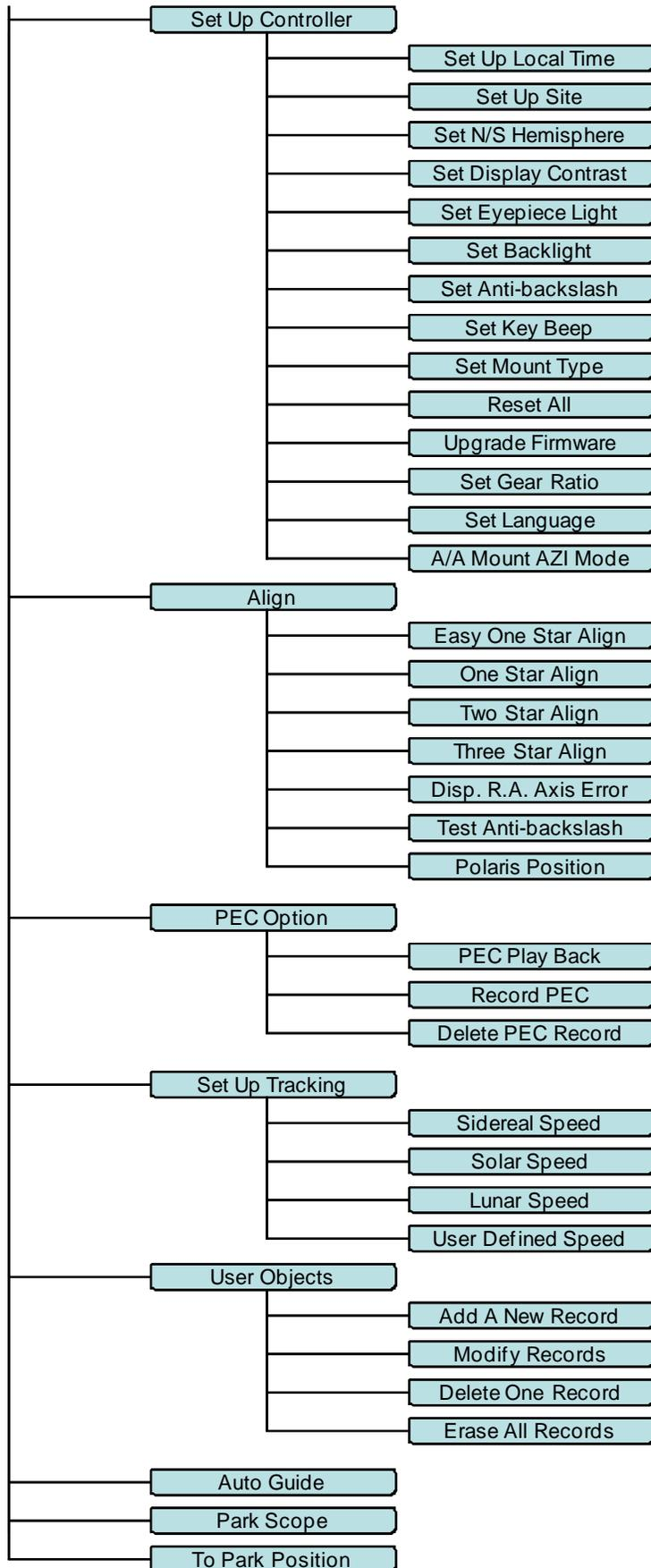

Appendix C. GTONOVA[®] Star List

GTONOVA Deep Sky Object List

ID No.	OBJECT	NGC #	Messier #	IC#	A(Abell)	U(UGC)
1	Andromeda Galaxy	224	31			
2	Barnards Galaxy	6822				
3	Beehive Cluster	2632	44			
4	Blackeye Galaxy	4926	64			
5	Blinking Planetary Nebula	6826				
6	Blue Flash Nebula	6905				
7	Blue Planetary	3918				
8	Blue Snowball Nebula	7662				
9	Box Nebula	6309				
10	Bubble Nebula	7635				
11	Bipolar Nebula	6302				
12	Butterfly Cluster	6405	6			
13	California Nebula	1499				
14	Cat's Eye Nebula	6543				
15	Cocoon Nebula			5146		
16	Cone Nebula	2264				
17	Cork Nebula	650-51	76			
18	Crab Nebula	1952	1			
19	Crescent Nebula	6888				
20	Draco Dwarf					10822
21	Duck Nebula	2359				
22	Dumbbell Nebula	6853	27			
23	Eagle Nebula		16			
24	Eight-Burst Nebula	3132				
25	Eskimo Nebula	2392				
26	Flaming Star Nebula			405		
27	Ghost of Jupiter	3242				
28	Great Cluster	6205	13			
29	Helix Nebula	7293				
30	Hercules Galaxy Cluster				2151	
31	Hind's Variable Nebula	1555				
32	Hubble's Variable Nebula	2261				
33	Integral Sign Galaxy					3697
34	Jewel Box Cluster	4755				

35	Keyhole Nebula	3372				
36	Lagoon Nebula	6523	8			
37	Little Gem	6445				
38	Little Gem Nebula	6818				
39	Little Ghost Nebula	6369				
40	North American Nebula	7000				
41	Omega Nebula	6618	17			
42	Orion Nebula	1976	42			
43	Owl Nebula	3587	97			
44	Pelican Nebula			5070		
45	Phantom Streak Nebula	6741				
46	Pinwheel Galaxy	598	33			
47	Pleiades		45			
48	Ring Nebula	6720	57			
49	Ring Tail Galaxy	4038				
50	Rosette Nebula	2237				
51	Saturn Nebula	7009				
52	Sextans B Dwarf					5373
53	Small Magellanic Cloud	292				
54	Sombrero Galaxy	4594	104			
55	Spindle Galaxy	3115				
56	Tank Track Nebula	2024				
57	Trifid Nebula	6514	20			
58	Ursa Minor Dwarf					9749
59	Whirlpool Galaxy	5194	51			
60	Wild Duck Cluster	6705	11			

Modern Constellations

No.	Constellation	Abbreviation
1	Andromeda	And
2	Antlia	Ant
3	Apus	Aps
4	Aquarius	Aqr
5	Aquila	Aql
6	Ara	Ara
7	Aries	Ari
8	Auriga	Aur
9	Boötes	Boo
10	Caelum	Cae
11	Camelopardalis	Cam
12	Cancer	Cnc
13	Canes Venatici	CVn
14	Canis Major	CMa
15	Canis Minor	CMi
16	Capricornus	Cap
17	Carina	Car
18	Cassiopeia	Cas
19	Centaurus	Cen
20	Cepheus	Cep
21	Cetus	Cet
22	Chamaeleon	Cha
23	Circinus	Cir
24	Columba	Col
25	Coma Berenices	Com
26	Corona Australis	CrA
27	Corona Borealis	CrB
28	Corvus	Crv
29	Crater	Crt
30	Crux	Cru
31	Cygnus	Cyg
32	Delphinus	Del
33	Dorado	Dor
34	Draco	Dra
35	Equuleus	Equ
36	Eridanus	Eri
37	Fornax	For
38	Gemini	Gem
39	Grus	Gru
40	Hercules	Her
41	Horologium	Hor
42	Hydra	Hya
43	Hydrus	Hyi
44	Indus	Ind

No.	Constellation	Abbreviation
45	Lacerta	Lac
46	Leo	Leo
47	Leo Minor	LMi
48	Lepus	Lep
49	Libra	Lib
50	Lupus	Lup
51	Lynx	Lyn
52	Lyra	Lyr
53	Mensa	Men
54	Microscopium	Mic
55	Monoceros	Mon
56	Musca	Mus
57	Norma	Nor
58	Octans	Oct
59	Ophiuchus	Oph
60	Orion	Ori
61	Pavo	Pav
62	Pegasus	Peg
63	Perseus	Per
64	Phoenix	Phe
65	Pictor	Pic
66	Pisces	Psc
67	Piscis Austrinus	PsA
68	Puppis	Pup
69	Pyxis	Pyx
70	Reticulum	Ret
71	Sagitta	Sge
72	Sagittarius	Sgr
73	Scorpius	Sco
74	Sculptor	Scl
75	Scutum	Sct
76	Serpens	Ser
77	Sextans	Sex
78	Taurus	Tau
79	Telescopium	Tel
80	Triangulum	Tri
81	Triangulum Australe	TrA
82	Tucana	Tuc
83	Ursa Major	UMa
84	Ursa Minor	UMi
85	Vela	Vel
86	Virgo	Vir
87	Volans	Vol
88	Vulpecula	Vul

GOTONOVA Named Star List for 8401

001 Acamar	049 Ascella	097 Kaus Australis	145 Rassalas
002 Achernar	050 Asellus Australis	098 Kaus Borealis	146 Rasagethi
003 Acrux	051 Asellus Borealis	099 Kaus Media	147 Rasalhague
004 Acubens	052 Aspidiske	100 Keid	148 Rastaba
005 Adhafera	053 Atik	101 Kitalpha	149 Regulus
006 Adhara	054 Atlas	102 Kochab	150 Rigel
007 Al Na'ir	055 Atria	103 Kornephoros	151 Rigel Kentaurus
008 Albali	056 Avoir	104 Kurhah	152 Ruchbah
009 Alberio	057 Azha	105 Lesath	153 Rukbat
010 Alchibar	058 Baten Kaitos	106 Maia	154 Sabik
011 Alcor	059 Beid	107 Marfik	155 Sadachbia
012 Alcyone	060 Bellatrix	108 Markab	156 Sadalbari
013 Aldebaran	061 Betelgeuse	109 Matar	157 Sadalmelik
014 Alderamin	062 Biham	110 Mebsuta	158 Sadalsuud
015 Alfirk	063 Canopus	111 Megrez	159 Sadr
016 Algedi	064 Capella	112 Meissa	160 Saiph
017 Algenib	065 Caph	113 Mekbuda	161 Scheat
018 Algiebra	066 Castor	114 Menkalinan	162 Schedar
019 Algol	067 Celabrai	115 Menkar	163 Seginus
020 Algorab	068 Celaeno	116 Menkent	164 Shaula
021 Alhena	069 Chara	117 Menkib	165 Sheiak
022 Alioth	070 Chertan	118 Merak	166 Sheratan
023 Alkaid	071 Cor Caroli	119 Merope	167 Sirius
024 Alkalurops	072 Cursa	120 Mesartim	168 Skat
025 Alkes	073 Dabih	121 Miaplacidus	169 Spica
026 Almach	074 Deneb	122 Mintaka	170 Sterope
027 Alnasl	075 Deneb Algedi	123 Mira	171 Sulafat
028 Alnilam	076 Deneb Kaitos	124 Mirach	172 Syrma
029 Alnitak	077 Denebola	125 Mirfak	173 Talitha
030 Alphard	078 Dubhe	126 Mirzam	174 Tania Australis
031 Alphecca	079 Edasich	127 Mizar	175 Tania Borealis
032 Alpheratz	080 Electra	128 Muphrid	176 Tarazed
033 Alrakis	081 Elnath	129 Muscida	177 Taygeta
034 Alrescha	082 Eltanin	130 Nashira	178 Thuban
035 Alshain	083 Enif	131 Nekkar	179 Unukalhai
036 Altair	084 Errai	132 Nihal	180 Vega
037 Altais	085 Fomalhaut	133 Nunki	181 Vindemiatrix
038 Alterf	086 Furud	134 Nusakan	182 Wasat
039 Aludra	087 Gacrux	135 Peacock	183 Wazn
040 Alula Australis	088 Giasar	136 Phact	184 Yed Posterior
041 Alula Borealis	089 Gienah	137 Phecda	185 Yed Prior
042 Alya	090 Gomeisa	138 Pherkad	186 Zaniah
043 Ancha	091 Graffias	139 Pleione	187 Zaurak
044 Ankaa	092 Groombridge 1830	140 Polaris	188 Zavijava
045 Antares	093 Grumium	141 Pollux	189 Zosma
046 Arcturus	094 Hamal	142 Porrima	190 Zubenelgenubi
047 Arkab	095 Homan	143 Procyon	191 Zubeneschamali
048 Arneb	096 Izar	144 Propus	

GOTONOVA Double Star List

for 8401

No.	Object	Const	SAO	Name
1	Eta	Cas	21732	Achird
2	Alpha	Psc	110291	Alrisha
3	Theta	Per	38288	
4	Alpha	For	168373	Fornacis
5	Alpha	Aur	40186	Capella
6	Sigma	Ori	132406	
7	Mu	Ori	113389	
8	Alpha	CMA	151881	Sirius
9	Delta	Gem	79294	Wasat
10	Alpha	Gem	60198	Castor
11	Alpha	CMi	115756	
12	Epsilon	Hya	117112	
13	HR 3579		42642	
14	Kapa	UMa	42661	
15	Psi	Vel	221234	
16	Gamma	Leo	81298	Algieba
17	HR 4167		222199	
18	Mu	Vel	222321	
19	Alpha	UMa	15384	Dubhe
20	Zeta	UMa	28737	Mizar
21	Iota	Leo	99587	
22	Gamma	Cen	223603	
23	Gamma	Vir	138917	Porrina
24	Beta	Mus	252019	
25	HR 5089		204545	
26	Alpha	Cen	252838	
27	Zeta	Boo	101145	
28	Gamma	Lup	225938	
29	Gamma	CrA	83958	
30	Xi	Sco	159665	
31	Alpha	Sco	184415	Antares
32	Lambda	Oph	121658	Marfic
33	Zeta	Her	65485	
34	Eta	Oph	160332	Sabik
35	70	Oph	123107	
36	Zeta	Sgr	187600	Ascella
37	Delta	Cyg	48796	
38	Beta	Del	106316	Rotanev
39	Tau	Cyg	71121	
40	Epsilon	Lyr	67310	double double

Appendix D. Set Up USB-PC Connection

1. Download USB2COM driver (cp2102.zip file for 8401) from iOptron Website
2. Install cp2101(usb2com) driver

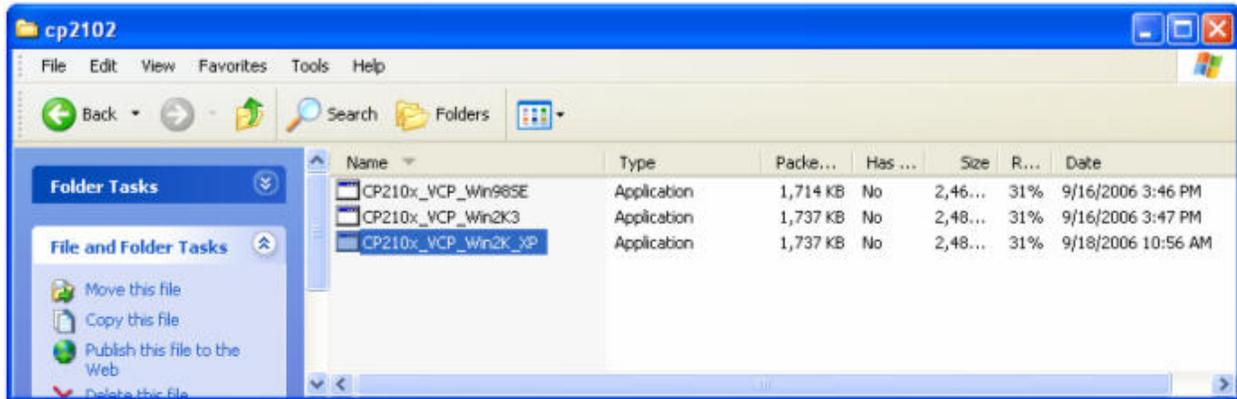

Choose the appropriate driver for your OS. In this case is a Windows XP operation system. Double click on it, and you will see:

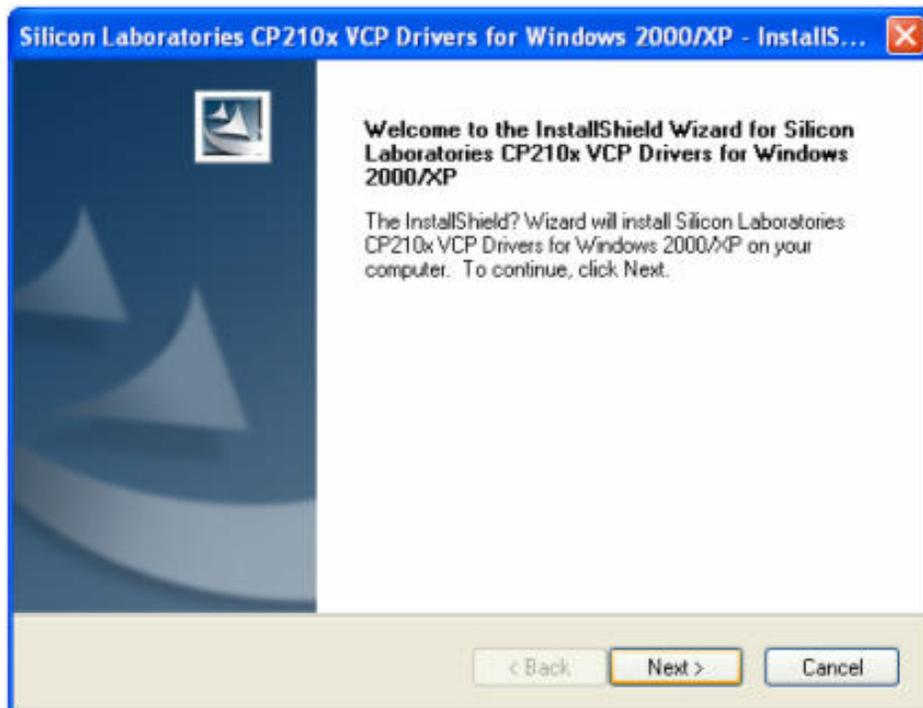

Click "Next".

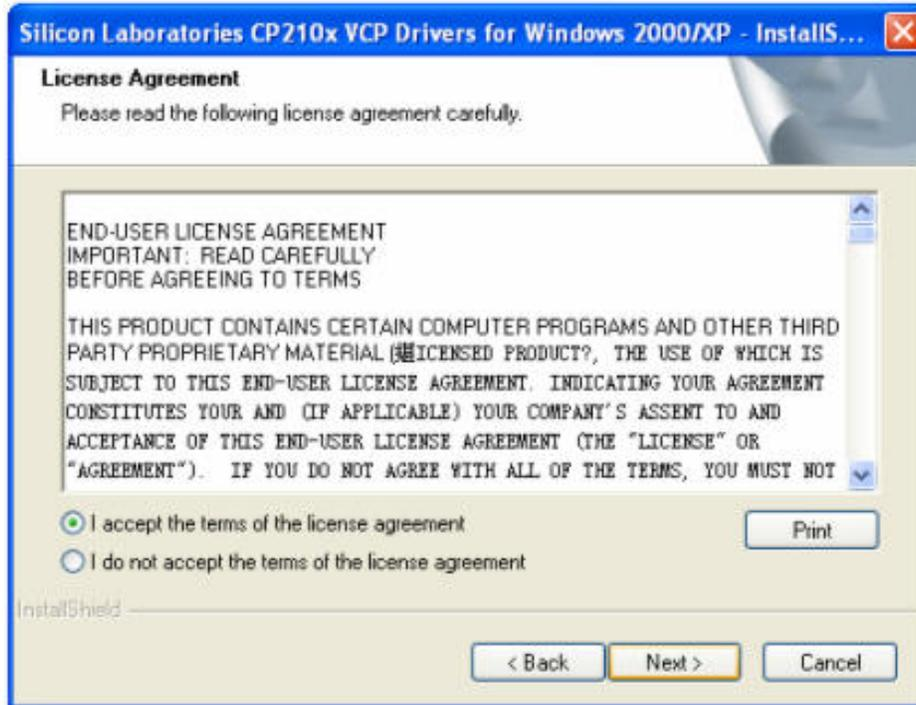

Select "I accept the terms of license agreement", and click "Next"

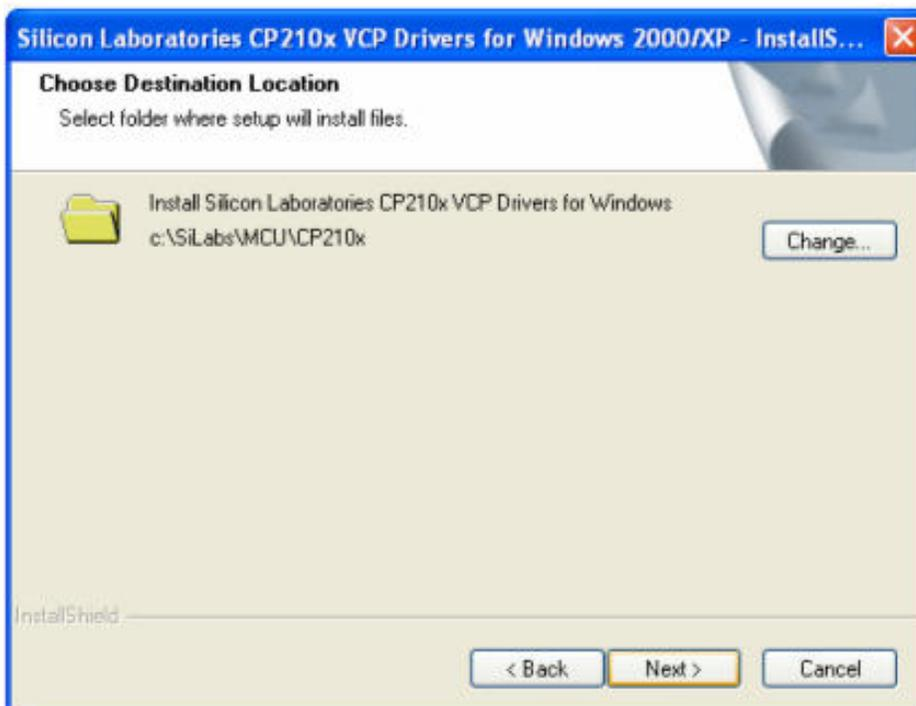

Using the default installation path, c:\SiLabs\MCU\CP210x, or specify your own path by click "Change". Click "Next". Then click "Install".

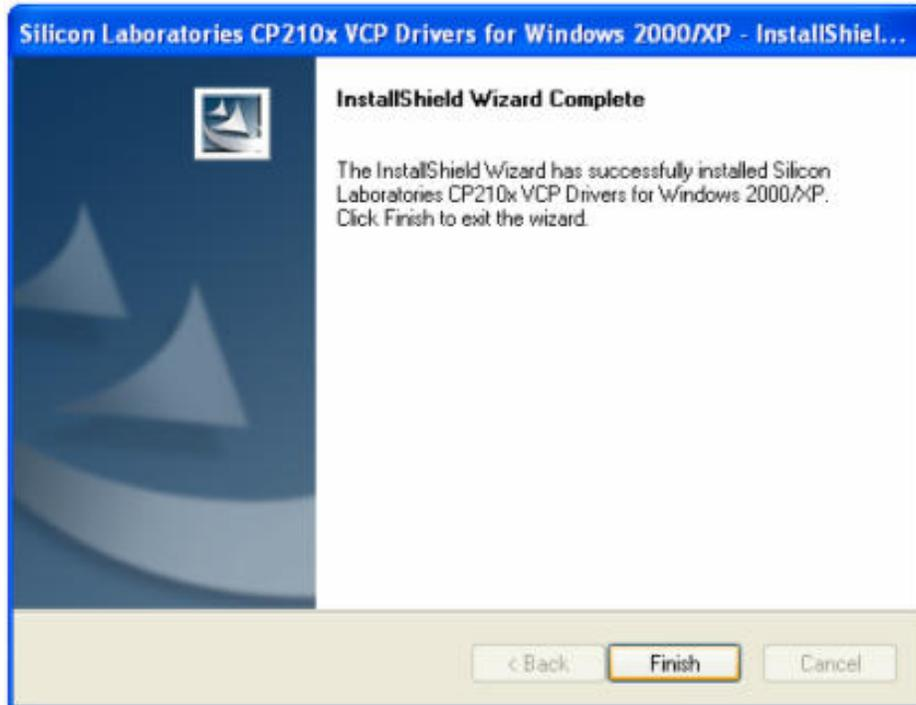

When finished installation, click "Finish"

- 3. Plug the USB cable to the USB port on your PC, plug the other end of the USB cable to hand controller. Turn on the power on the mount.**

4. Install the Hardware

The computer will find a new hardware and show the following screen



Select "No, not this time" and click "Next".

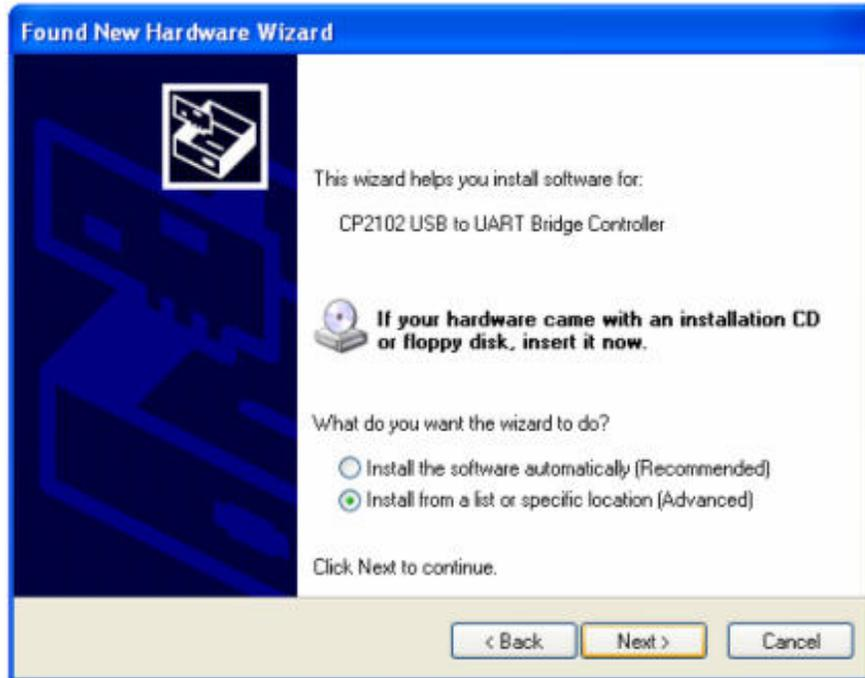

Select “Install from a list or specific location” and click “Next”.

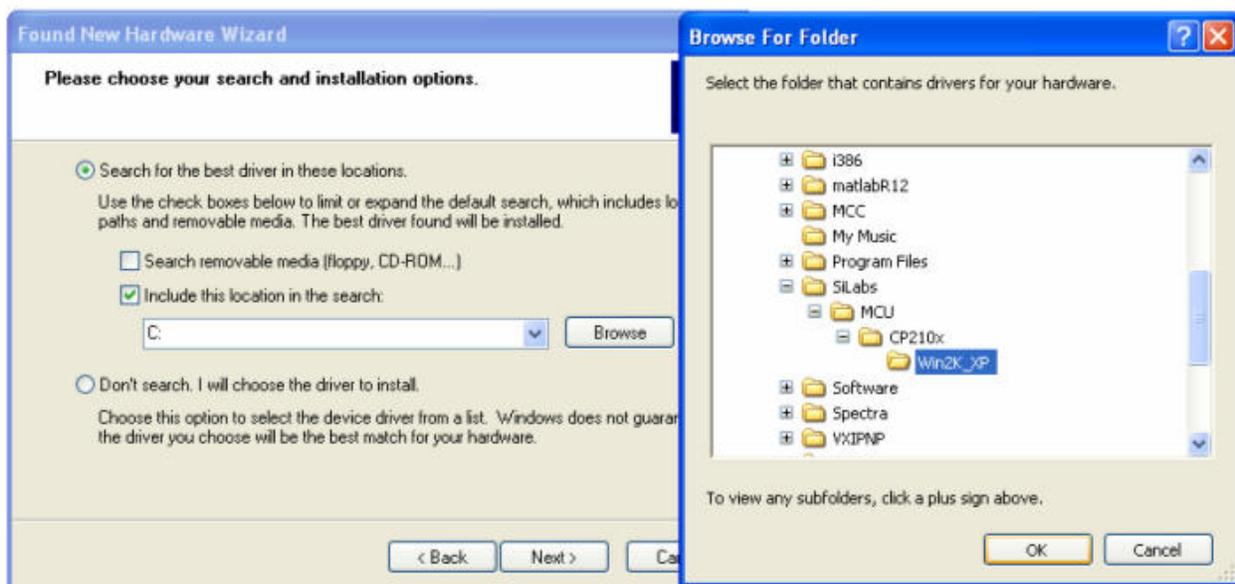

Select “Search for the best driver in these locations,” and check “Include this location in the search.”

Click on “Browse” and select the cp210x driver from directory c:\SiLabs\MCU\CP210x\Win2K_XP, click OK.

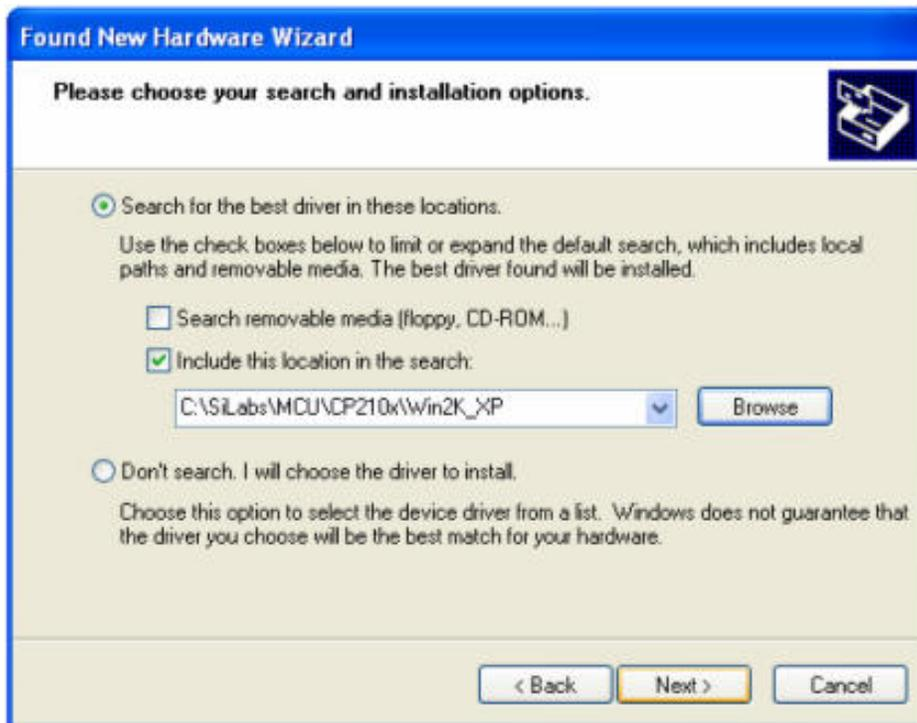

Click “Next”. The computer will start to install the driver for the USB2COM. When the installation is done, click “Finish”.



If the computer shows “find a new hardware” screen again, just repeat the steps in this section again.

Now your computer should be ready for Firmware Upgrading; computer communication with the mount via ASCOM platform; and planetarium software applications. However, you need to find assigned COM port number for the USB connection. To do so, right click “My Computer”, and click “Properties”

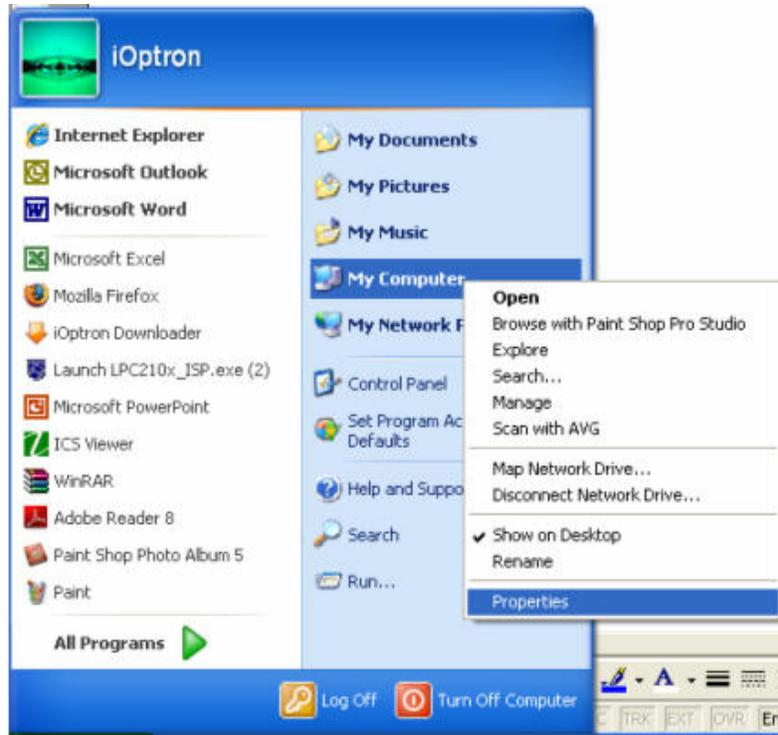

Click “Hardware”, click “Device Manager”

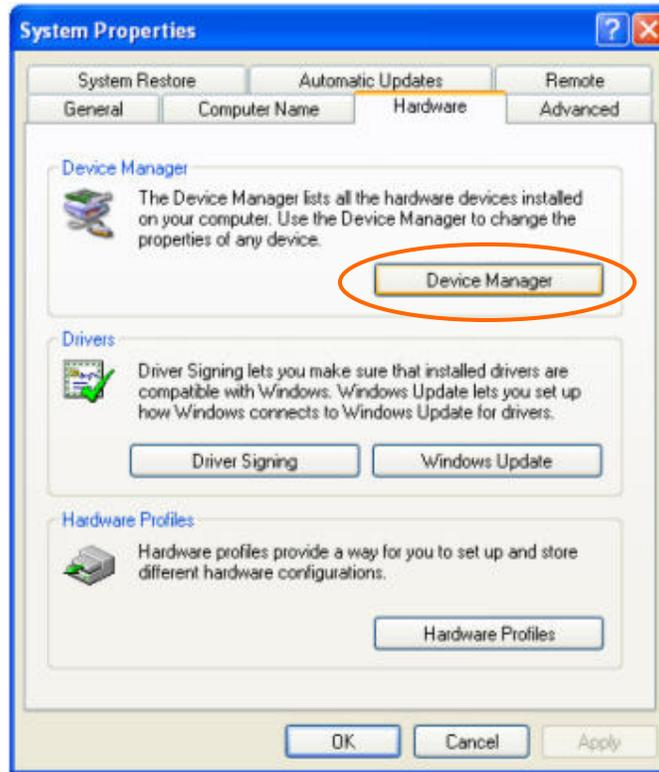

Double click on “Ports (COM & LPT)”. Find the COM number and write it down (in the following figure, it is COM4)

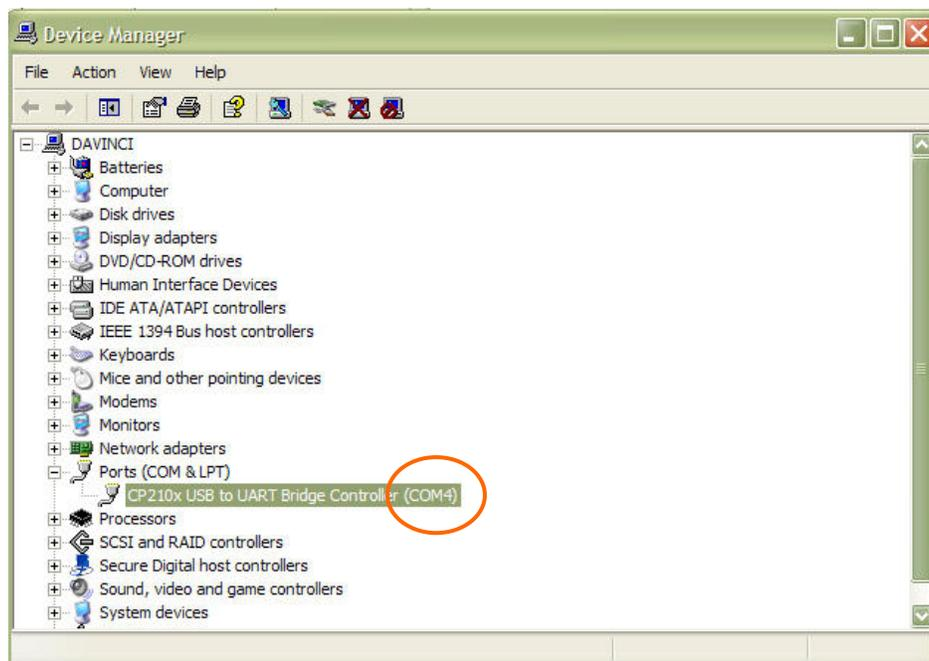

Appendix E. Firmware Upgrade

1. Download and install Firmware Downloader from iOptron Website
2. Double click and open “iOptron Downloader”

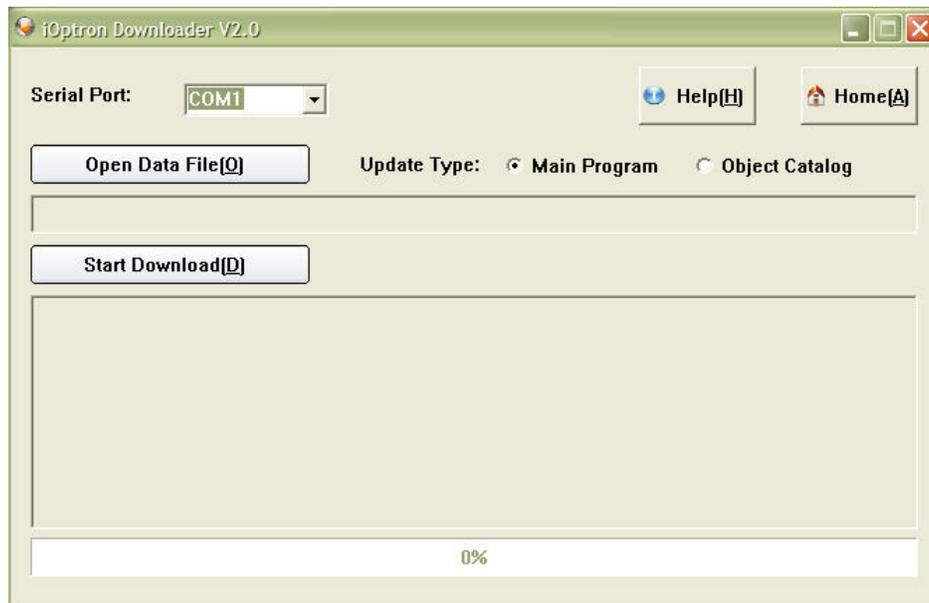

On the interface, select appropriate port using pull-down menu (in this case, COM4):

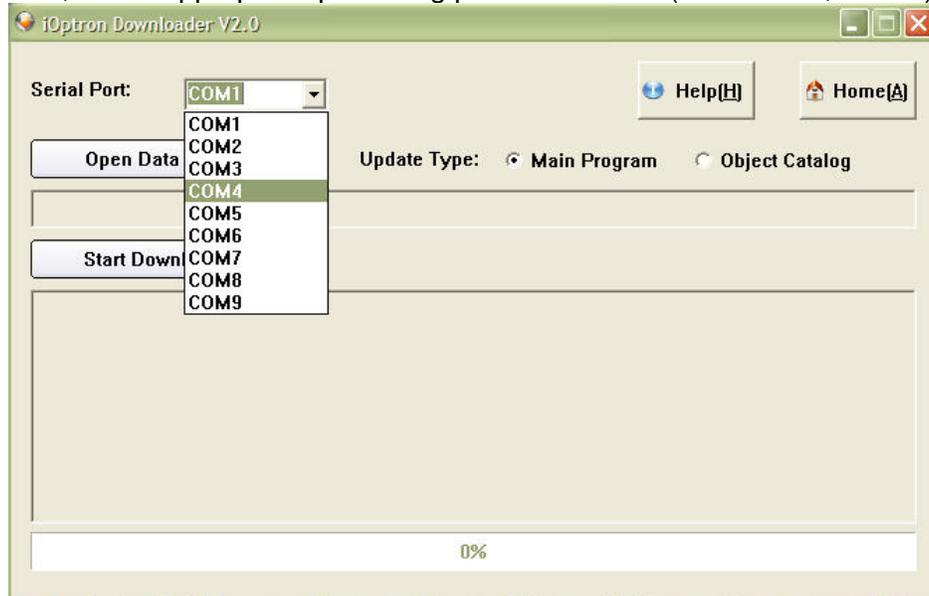

Click “Open Data File” and select the appropriate “.bin” file that matches your hand controller.

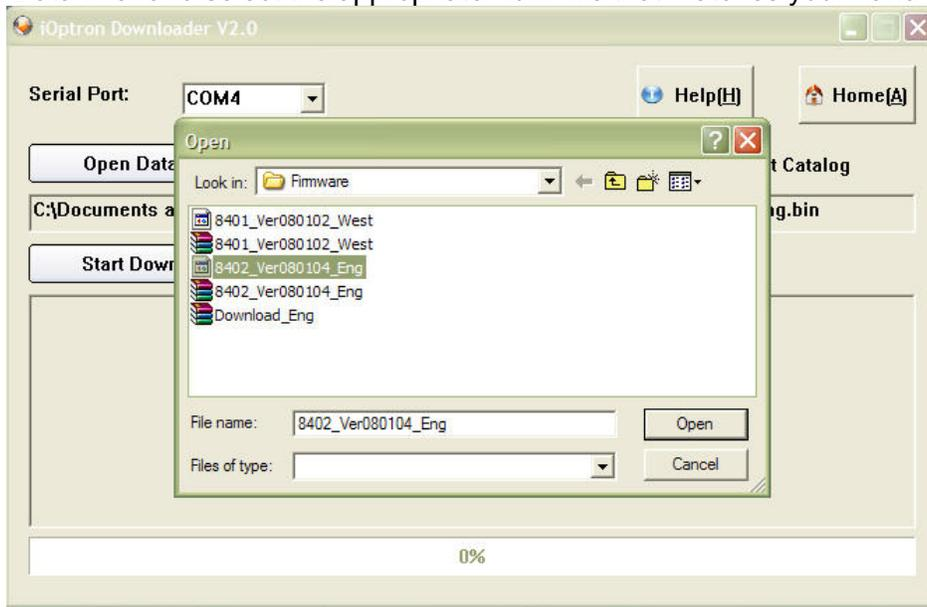

Then click “Open”. Select “Main Program” in Update Type.

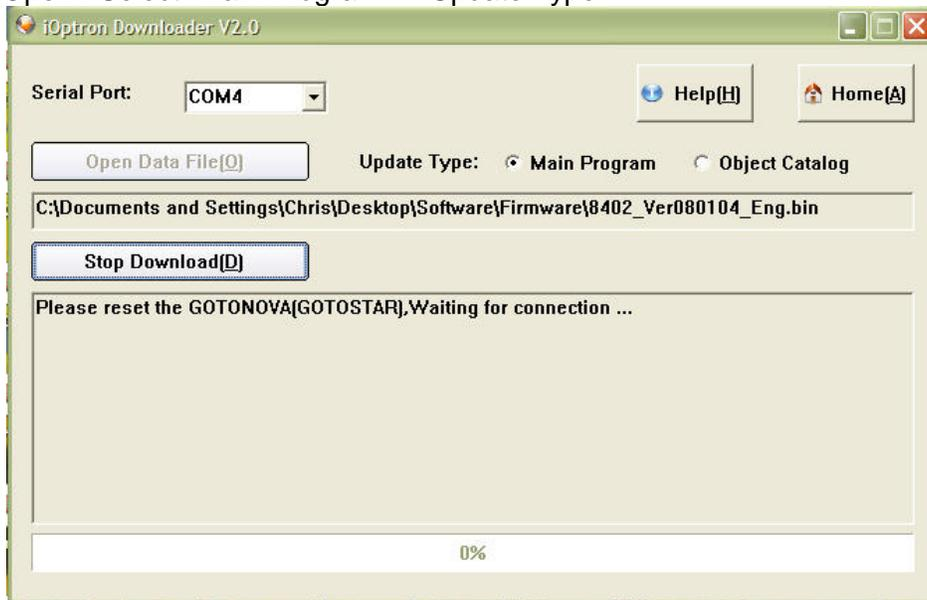

Click “Start Download”

It shows “Please reset GOTONOVA[GOTOSTAR], waiting for connection...”

On the hand controller, press “MENU”, and using ▼▲ scroll to select “Set u controller”, press “ENTER”, then select “Upgrade firmware”, press “ENTER” and the upgrade will start.

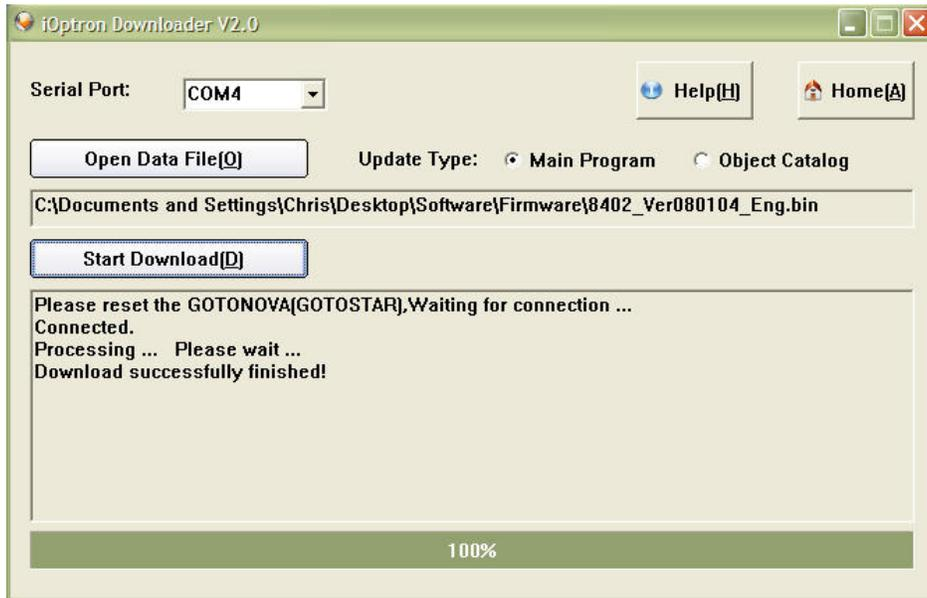
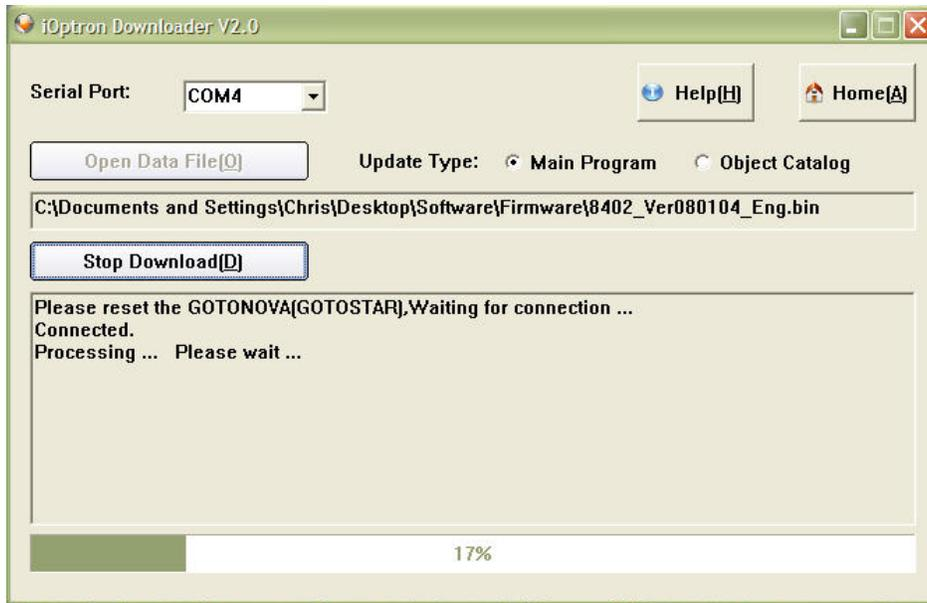

The upgrade is complete. Turn your mount power off then on again.

Typical Errors:

1. Invalid Port Number: in Device Manager: make sure you have the correct COM port number for CP210x.
2. Screen is now blank: Wrong ".bin" file: make sure you have the correct ".bin" file for firmware upgrade.
3. Wrong downloader: you should use iOptron Downloader instead of the Flash Downloader.
4. Use cp210x driver provided by iOptron. The newest version from SiLab may not work properly for iOptron's hand controller.

Appendix F. Use a PC to Control an iOptron Mount

In general you need the followings to use a PC to control the mount,

1. Download USB2COM driver from iOptron website;
2. Install USB2COM and establish the connection between the mount and the PC (see instruction);
3. Download ASCOM platform from <http://ascom-standards.org/>, and install it;
4. Download iOptron ASCOM drive from iOptron website and install it; and
5. Planetarium software.

Some company integrated iOptron's products into their planetarium software, such as Voyage and The Sky X Pro. Therefore, an ASCOM plug-in will not be needed. Most planetarium software can be used to control iOptron's product via ASCOM.

Some other ASCOM drivers such as LX200 Generic ASCOM driver and AstroPhysics GTO mount driver may also be compatible with the SmartStar[®] mount.

IOPTRON TWO YEAR TELESCOPE, MOUNT, AND CONTROLLER WARRANTY

A. iOptron warrants your telescope, mount, or controller to be free from defects in materials and workmanship for two years. iOptron will repair or replace such product or part which, upon inspection by iOptron, is found to be defective in materials or workmanship. As a condition to the obligation of iOptron to repair or replace such product, the product must be returned to iOptron together with proof-of-purchase satisfactory to iOptron.

B. The Proper Return Authorization Number must be obtained from iOptron in advance of return. Call iOptron at 1.866.399.4587 to receive the number to be displayed on the outside of your shipping container. All returns must be accompanied by a written statement stating the name, address, and daytime telephone number of the owner, together with a brief description of any claimed defects. Parts or product for which replacement is made shall become the property of iOptron.

The customer shall be responsible for all costs of transportation and insurance, both to and from the factory of iOptron, and shall be required to prepay such costs.

iOptron shall use reasonable efforts to repair or replace any telescope, mount, or controller covered by this warranty within thirty days of receipt. In the event repair or replacement shall require more than thirty days, iOptron shall notify the customer accordingly. iOptron reserves the right to replace any product which has been discontinued from its product line with a new product of comparable value and function.

This warranty shall be void and of no force of effect in the event a covered product has been modified in design or function, or subjected to abuse, misuse, mishandling or unauthorized repair. Further, product malfunction or deterioration due to normal wear is not covered by this warranty.

IOPTRON DISCLAIMS ANY WARRANTIES, EXPRESS OR IMPLIED, WHETHER OF MERCHANTABILITY OF FITNESS FOR A PARTICULAR USE, EXCEPT AS EXPRESSLY SET FORTH HERE. THE SOLE OBLIGATION OF IOPTRON UNDER THIS LIMITED WARRANTY SHALL BE TO REPAIR OR REPLACE THE COVERED PRODUCT, IN ACCORDANCE WITH THE TERMS SET FORTH HERE. IOPTRON EXPRESSLY DISCLAIMS ANY LOST PROFITS, GENERAL, SPECIAL, INDIRECT OR CONSEQUENTIAL DAMAGES WHICH MAY RESULT FROM BREACH OF ANY WARRANTY, OR ARISING OUT OF THE USE OR INABILITY TO USE ANY IOPTRON PRODUCT. ANY WARRANTIES WHICH ARE IMPLIED AND WHICH CANNOT BE DISCLAIMED SHALL BE LIMITED IN DURATION TO A TERM OF TWO YEARS FROM THE DATE OF ORIGINAL RETAIL PURCHASE.

Some states do not allow the exclusion or limitation of incidental or consequential damages or limitation on how long an implied warranty lasts, so the above limitations and exclusions may not apply to you.

This warranty gives you specific legal rights, and you may also have other rights which vary from state to state.

iOptron reserves the right to modify or discontinue, without prior notice to you, any model or style telescope.

If warranty problems arise, or if you need assistance in using your telescope, mount, or controller contact:

iOptron Corporation
Customer Service Department
6E Gill Street
Woburn, MA 01801
www.ioptron.com
e-mail: support@ioptron.com
Tel. (866)399-4597
Fax. (781)935-2860
Monday-Friday 9AM-5PM EST

NOTE: This warranty is valid to U.S.A. and Canadian customers who have purchased this product from an authorized iOptron dealer in the U.S.A. or Canada or directly from iOptron. Warranty outside the U.S.A. and Canada is valid only to customers who purchased from an iOptron Distributor or Authorized iOptron Dealer in the specific country. Please contact them for any warranty